

GARMIN®

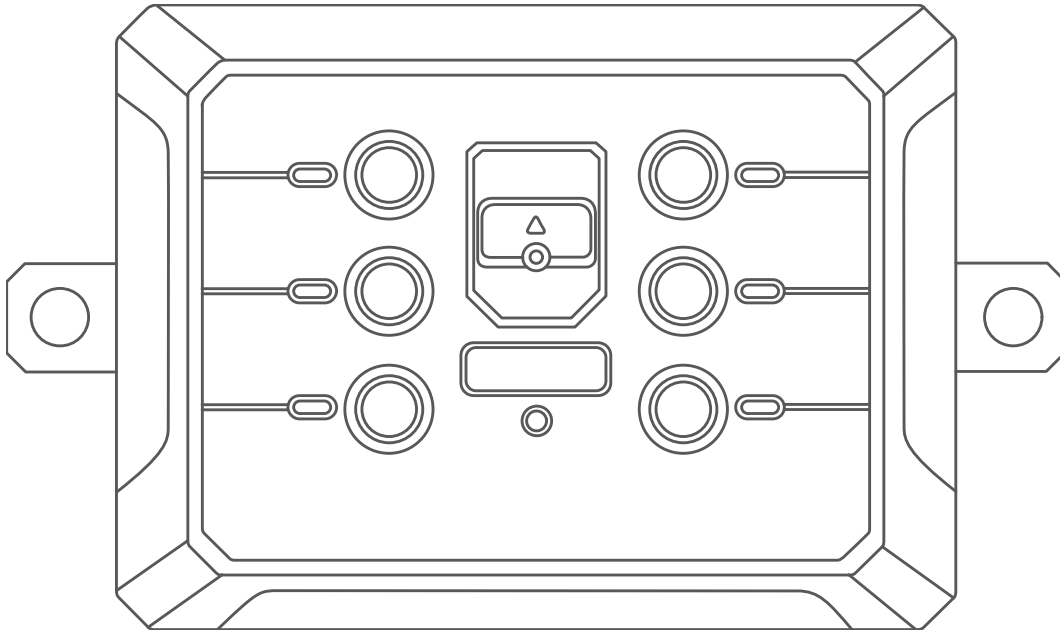

GARMIN POWERSWITCH™

Owner's Manual

© 2021 Garmin Ltd. or its subsidiaries

All rights reserved. Under the copyright laws, this manual may not be copied, in whole or in part, without the written consent of Garmin. Garmin reserves the right to change or improve its products and to make changes in the content of this manual without obligation to notify any person or organization of such changes or improvements. Go to www.garmin.com for current updates and supplemental information concerning the use of this product.

Garmin® and the Garmin logo are trademarks of Garmin Ltd. or its subsidiaries, registered in the USA and other countries. Garmin PowerSwitch™ is a trademark of Garmin Ltd. or its subsidiaries. These trademarks may not be used without the express permission of Garmin.

The BLUETOOTH® word mark and logos are owned by the Bluetooth SIG, Inc., and any use of such name by Garmin is under license.

Table of Contents

Getting Started	1	Device Information	14
Device Overview	2	Garmin PowerSwitch Specifications...	14
Installation	2	Index	15
Mounting Considerations	2		
Mounting the Device.....	3		
Opening the Front Cover	4		
Connecting Accessories.....	5		
Connecting a Control Input.....	6		
Connecting the Device to Vehicle Power	7		
Pairing and Setup	8		
Pairing with a Garmin Navigation Device.....	8		
Pairing with Your Smartphone.....	8		
Pairing an Additional Garmin PowerSwitch Device.....	8		
Garmin PowerSwitch App	9		
Activating a Power Switch.....	9		
Turning Off All Switches.....	9		
Customizing a Button.....	10		
Assigning a Switch to a Control Input.....	10		
Adding a Custom Layout.....	10		
Routines.....	11		
Device Maintenance	12		
Garmin Support Center.....	12		
Device Care.....	12		
Changing the Fuse in the Vehicle Power Cable.....	13		
Updating Device Firmware.....	13		
Restoring Device Settings.....	13		
Troubleshooting	14		
My Garmin PowerSwitch will not stay connected.....	14		
My accessories are not receiving power.....	14		
Can I mount the device in an engine compartment?.....	14		
Can the device get wet?.....	14		

Getting Started

WARNING

See the *Important Safety and Product Information* guide in the product box for product warnings and other important information.

CAUTION

Garmin® strongly recommends having an experienced installer with proper knowledge of electrical systems install the device. Incorrectly wiring the power cables can result in damage to the device, the vehicle, or the battery, and can cause bodily injury.

NOTICE

Disconnect the negative battery terminal in the vehicle before installing the device to prevent an electrical short circuit. Reconnect the vehicle battery terminals only after installation is complete.

- 1 Mount the device (*Mounting Considerations, page 2*).
- 2 Connect accessories to the device (*Connecting Accessories, page 5*).
- 3 Connect a control input (optional) (*Connecting a Control Input, page 6*).
- 4 Connect the device to vehicle power (*Connecting the Device to Vehicle Power, page 7*).
- 5 Pair your device with a compatible Garmin navigation device (*Pairing with a Garmin Navigation Device, page 8*) or a smartphone (*Pairing with Your Smartphone, page 8*).

Device Overview

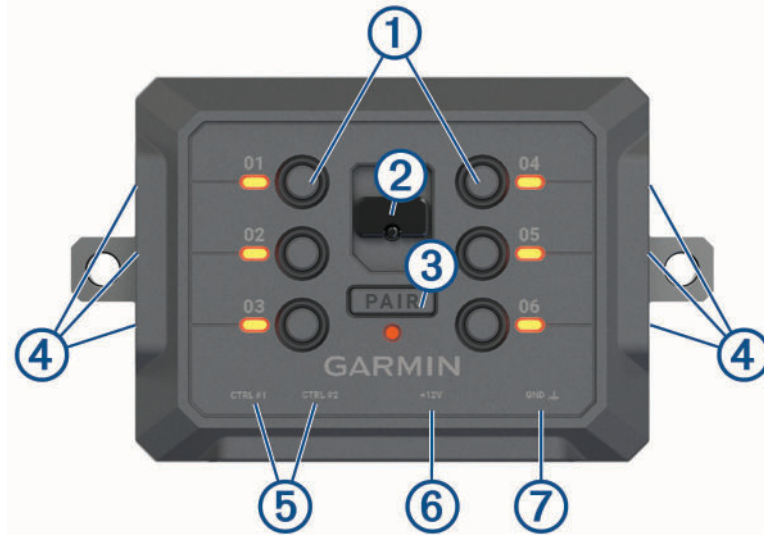

①	Accessory switches
②	Cover latch
③	Pairing button
④	Accessory terminals with #8-32 screws
⑤	Control terminals with #8-32 screws
⑥	+12V terminal
⑦	Device ground terminal (GND)

Installation

Mounting Considerations

- The device must be mounted close to the battery and within the range of the supplied power cable.
- The mounting surface must be strong enough to support the weight of the device.
- The location must allow room for the routing and connection of all cables.

Mounting the Device

Before you can mount the device, you must select a mounting location and purchase the appropriate hardware for your mounting surface.

NOTICE

Avoid wires, gauges, air bags, air bag covers, HVAC, and other items when drilling pilot holes and attaching the mount to the vehicle. Garmin is not responsible for any damages or consequences arising from the installation.

- 1 Place the mount on the selected location.



- 2 Using the mount as a template, mark the two screw locations ①.
- 3 Drill pilot holes (optional).
For some types of mounting material, drilling pilot holes is necessary. Do not drill through the mount.
- 4 Securely fasten the mount to the surface using the appropriate hardware for your mounting surface.

Opening the Front Cover

You must open the front cover to make electrical connections.

- 1 Lift the front cover latch ① and rotate it counter-clockwise.



- 2 Pull the front cover off of the device.



Connecting Accessories

NOTICE

Do not use the device to control or power a winch. Failure to follow this notice could cause damage to your vehicle or your device.

Do not connect a power source to an accessory output terminal. Failure to follow this notice could cause damage to your vehicle or your device.

Accessory requirements:

- Verify the amperage rating of each accessory before wiring it to the Garmin PowerSwitch device. The device supports accessories up to 30 A for each channel and a maximum of 100 A for the entire system.
 - Use 10 AWG (6 mm²) wires for accessories that use 20 to 30 A.
 - Use 12 AWG (4 mm²) wires for accessories that use 10 to 20 A.
 - Use 14 AWG (2.5 mm²) wires for accessories that use less than 10 A.
 - Use the appropriate size terminals for all accessory connections.
 - Crimp all terminal connectors securely.
- 1 Connect the positive wire from the accessory ① to one of the accessory terminals ② on the Garmin PowerSwitch device.

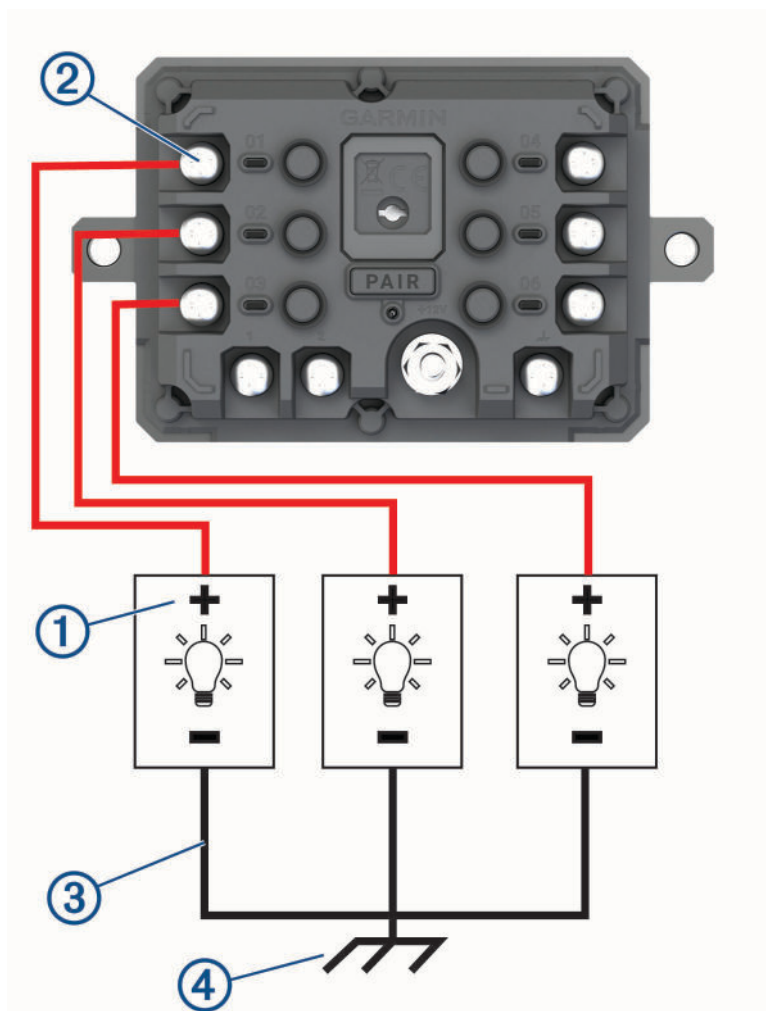

- 2 Connect the negative or ground wire ③ to an unpainted ground stud ④ on the vehicle frame, to a ground distribution block, or directly to the negative terminal on the battery.

NOTICE

Do not connect the accessory ground wires to the ground terminal (GND) on the Garmin PowerSwitch device. Failure to heed this notice could result in personal or property damage, or negatively impact device functionality.

- 3 Verify that all electrical connections are tight and will not come loose during use.

Electrical Circuit Protections

The Garmin PowerSwitch device limits the amount of electrical current for each output terminal. If a single output exceeds 30 A, the device turns off that output automatically. If the device detects a total system load of more than 100 A, the device turns off all outputs automatically.

Connecting a Control Input

You can connect to the control terminals to enable the Garmin PowerSwitch device to turn on customizable outputs. For example, you can connect your vehicle ignition switch to a control input terminal to turn on accessories automatically each time you start your vehicle. The control terminals detect a signal from 3.3 V to 18 V. You can configure output functions with the Garmin PowerSwitch app.

Connect the control wire from the control source in your vehicle to one of the two control terminals on the Garmin PowerSwitch device.

Connecting the Device to Vehicle Power

Before you can connect the device to vehicle power, you must remove the warning tag from the +12V terminal on the device.

You should always confirm all electrical connections are secure and will not come loose while operating the device.

- 1 Connect the large ring end of the included ground wire ① to the negative terminal on the vehicle battery.

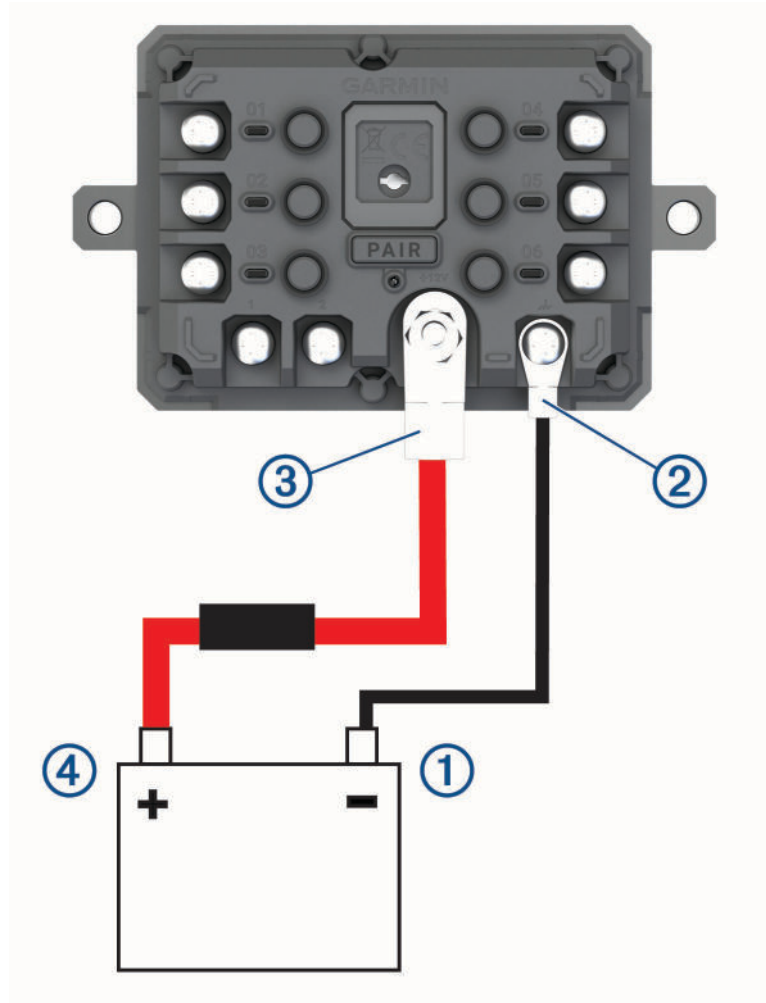

- 2 Connect the small ring end of the ground wire to the **GND** terminal ② on the device.
- 3 Connect the small ring end of the included 12V cable to the **+12V** terminal ③ on the device.
- 4 Tighten the $\frac{3}{8}$ in. nut on the +12V terminal to a maximum torque specification of 4.52 N-m (40 lbf-in.). You should confirm the nut cannot be loosened by hand.

NOTICE

Do not overtighten the +12V terminal to prevent damage to the terminal.

- 5 Connect the large ring end of the 12V cable ④ to the positive terminal on the vehicle battery.

Pairing and Setup

Pairing with a Garmin Navigation Device

You can pair your Garmin PowerSwitch device with a compatible Garmin navigation device.

- 1 Turn on power to your Garmin PowerSwitch device, and place your compatible Garmin navigation device within 1 m (3.3 ft.) of it.
- 2 On your compatible navigation device, open the Garmin PowerSwitch app.
- 3 Follow the on-screen instructions to complete the pairing and setup process.

The main app dashboard appears. After the devices are paired, they connect automatically when they are turned on and within range.

Pairing with Your Smartphone

You can pair your Garmin PowerSwitch device with your smartphone and the Garmin PowerSwitch app to enable wireless digital switching.

- 1 From the app store on your smartphone, install the Garmin PowerSwitch app.
- 2 Turn on power to your Garmin PowerSwitch device, and place your smartphone within 1 m (3.3 ft.) of your device.
- 3 On your smartphone, open the Garmin PowerSwitch app.
- 4 Follow the on-screen instructions to complete the pairing and setup process.

The main app dashboard appears. After the devices are paired, they connect automatically when they are turned on and within range.

Pairing an Additional Garmin PowerSwitch Device

You can pair up to four Garmin PowerSwitch devices with your smartphone or navigation device.

- 1 From the Garmin PowerSwitch app, select **Settings > Add Another Device**.
- 2 Follow the on-screen instructions to complete the pairing and setup process.

Garmin PowerSwitch App



① Settings	Opens the app settings menu
② Edit	Enters editing mode to customize the app layout and functions
③ Off	Turns off all outputs
④ Power buttons	Activates each connected output
⑤	Displays input voltage
⑥	Displays the total amperage of the selected Garmin PowerSwitch device
⑦	Displays the device name
⑧	Displays Garmin PowerSwitch device tabs and custom layout tabs

Activating a Power Switch



Before you can use the Garmin PowerSwitch app to activate a switch, you must install your Garmin PowerSwitch device in your vehicle and pair it with the Garmin PowerSwitch app.

From the Garmin PowerSwitch app, select a power button to turn a switch on or off.

Turning Off All Switches

Select **Off**.

Customizing a Button

- 1 From the Garmin PowerSwitch app screen, select **Edit**.
The app enters editing mode.
- 2 Select  on the button you want to customize.
- 3 Select an option:
 - To change the name of the button, select the **Button Label** field, and enter a name.
 - To add an icon to the button, select the **Icon** field, and select an icon.
 - To change the button color, select a color.
 - To change the button mode, select a button mode.
 - To adjust the intensity of the switch, use the slider.
 - To set the button to activate with a control input, select a control input.
- 4 Select .
- 5 Select **Done**.

Assigning a Switch to a Control Input

Before you can use control input functions, you must connect a control input to your Garmin PowerSwitch device ([Connecting a Control Input, page 6](#)).

You can assign one or more switches to turn on when the Garmin PowerSwitch device receives a signal from a control input.



- 1 Select **Settings**.
- 2 Select your Garmin PowerSwitch device.
- 3 Select a control input.
- 4 Select one or more switches.

Adding a Custom Layout

You can add a custom layout tab to the Garmin PowerSwitch app. Buttons added to a custom layout can control multiple switches at the same time.

- 1 From the Garmin PowerSwitch app, select **Edit**.
The device enters editing mode.
- 2 Select .



Adding a Button to a Custom Layout

- 1 From the Garmin PowerSwitch app, select a custom layout tab.
- 2 Select **Edit**.
The app enters editing mode.
- 3 Select **Add Button**.
- 4 On the new button, select .
- 5 Select an option:
 - To change the name of the button, select the **Button Label** field, and enter a name.
 - To add an icon to the button, select the **Icon** field, and select an icon.
 - To change the button color, select a color.
- 6 Select **Add Action**.
- 7 If necessary, select a Garmin PowerSwitch device and a switch.
- 8 Select an action:
 - To set the button to turn the switch on or off with each press, select **Toggle**.
 - To set the button to turn on the switch, select **Turn On**.
 - To set the button to turn off the switch, select **Turn Off**.
- 9 Select a button mode:
 - To set the button to activate with one touch, select **Normal**.
 - To set the button to activate only while touching the button, select **Momentary**.
 - To set the button to turn on and off repeatedly, select **Strobe**, and select time intervals.
- 10 If applicable, use the slider to set the brightness of lights.
- 11 Select .
- 12 If necessary, select **Add Action** to add additional actions for the button.
You can add one action for every switch on the Garmin PowerSwitch device.

Arranging Buttons In a Custom Layout

- 1 From the Garmin PowerSwitch app, select a custom layout tab.
- 2 Select **Edit**.
The app enters editing mode.
- 3 On the button you want to move, hold  and drag the button to a new location.

Deleting a Custom Layout or Button

- 1 From the Garmin PowerSwitch app, select a custom layout tab.
- 2 Select **Edit**.
The app enters editing mode.
- 3 Select an option:
 - To delete a button, select  on the button you want to delete.
 - To delete a layout tab, select  on the layout tab.



Routines

Routines automate your Garmin PowerSwitch device. When you define a routine on your compatible Garmin navigation device, it turns switches on or off automatically when the conditions of the routine are met. For example, you can set a routine to turn on a switch at specific time each day or when your vehicle reaches a specific speed. Routines are available only when using a compatible Garmin navigation device.



Adding a Routine

- 1 From the Garmin PowerSwitch app, select  > **Routines**.
- 2 If necessary, select **Add Routine**.
- 3 Select **When**.
- 4 Select a trigger:
 - To set a switch to trigger when your vehicle reaches a specific speed, select **Speed** > **Next**, and follow the on-screen instructions to enter speed thresholds.
 - To set a switch to trigger at a specific time each day, select **Time** > **Next**, and enter a time.
 - To set a switch to trigger at sunrise, select **Sunrise**.
 - To set a switch to trigger at sunset, select **Sunset**.
- 5 Select **Add Action**.
- 6 Select a device, a switch, an action, and a button mode.
- 7 If necessary, use the slider to adjust the dimmer.
- 8 Select **Save**.

Editing a Routine

- 1 From the Garmin PowerSwitch app, select  > **Routines**.
- 2 Select  on the routine you want to edit.
- 3 Select an option:
 - To change the trigger for the routine, select **When**, and select a trigger.
 - To change an action, select  on the action you want to change, and update the action.
 - To add an action to the routine, select **Add Action**, and enter information about the action.
- 4 Select **Save**.

Deleting a Routine

- 1 From the Garmin PowerSwitch app, select  > **Routines**.
- 2 Select  on the routine you want to delete.

Device Maintenance

Garmin Support Center

Go to support.garmin.com for help and information, such as product manuals, frequently asked questions, videos, and customer support.

Device Care

NOTICE

Avoid extreme shock and harsh treatment, because it can degrade the life of the product.

Do not use a sharp object to clean the device.

Avoid chemical cleaners, solvents, and insect repellents that can damage plastic components and finishes.

Do not store the device where prolonged exposure to extreme temperatures can occur, because it can cause permanent damage.

Cleaning the Outer Casing

NOTICE

Avoid chemical cleaners and solvents that can damage plastic components.

- 1 Clean the outer casing of the device using a cloth dampened with a mild detergent solution.
- 2 Wipe the device dry.

Changing the Fuse in the Vehicle Power Cable

NOTICE

When replacing the fuse, do not lose any of the small pieces and make sure they are put back in the proper position. The vehicle power cable does not work unless it is assembled correctly.

If your device does not receive power in your vehicle, you may need to replace the fuse located on the red power cable.

- 1 Pull up the top cover ① from the top of the in-line fuse assembly.

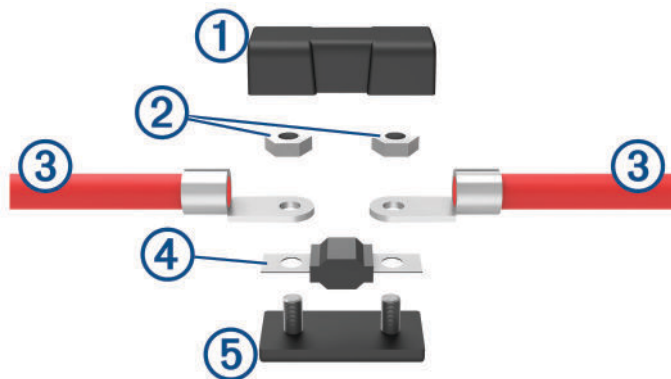

- 2 Using an 8 mm ($\frac{5}{16}$ in.) wrench, remove the two nuts ② that secure the two parts of the power cable ③ to the in-line fuse assembly.
- 3 Disconnect the power cables.
- 4 Remove the fuse ④ from the bottom cover ⑤.
- 5 Place a new 125 A fuse on the bottom cover.
- 6 Reinstall the power cables and nuts.
- 7 Tighten the nuts to a maximum torque specification of 2.26 N-m (20 lbf-in.).
- 8 Reinstall the top cover.

Updating Device Firmware

The Garmin PowerSwitch app notifies you when firmware updates for your Garmin PowerSwitch device are ready to install.

When the update notification appears, follow the on-screen instructions to complete the update process.

NOTE: Do not disconnect power during the update process.

Restoring Device Settings

The Garmin PowerSwitch app enables you to reset the device to the factory default values.

- 1 From the Garmin PowerSwitch app, select **Settings**.
- 2 Select a Garmin PowerSwitch device.
- 3 Select **Restore Defaults**.

Troubleshooting

My Garmin PowerSwitch will not stay connected

- Verify the Garmin PowerSwitch device is receiving power.
- Verify that Bluetooth® technology is enabled on your paired navigation device or smartphone.
- Move the navigation device or smartphone closer to your Garmin PowerSwitch device.
- Verify that your vehicle's battery is supplying at least 12 V of power.

The Garmin PowerSwitch device turns off all outputs automatically to preserve your vehicle's battery if it is receiving less than 11 V of power (*My accessories are not receiving power, page 14*).

My accessories are not receiving power

- Verify the Garmin PowerSwitch device is receiving power from the vehicle battery.
- Verify that your vehicle's battery is supplying at least 12 V of power.

The Garmin PowerSwitch device turns off all outputs automatically to preserve your vehicle's battery if it is receiving less than 11 V of power. Outputs turn back on when the device detects more than 12 V of power.

- Verify that all electrical connections are secure and will not come loose while operating the vehicle.
- Verify that each connected accessory draws less than 30 A.

If an accessory draws more than 30 A, the device turns off that output automatically.

- Verify that the total system load is less than 100 A.

If the device detects a system load of more than 100 A, it turns off all outputs automatically.

- Inspect all electrical connections for an electrical short circuit.

Can I mount the device in an engine compartment?

You can mount the device in an engine compartment as long as the temperature of the engine compartment does not exceed 85°C (185°F) . Do not mount the device near a turbocharger or an exhaust manifold.

Can the device get wet?

The device is designed to operate in wet conditions, and it can be submerged for limited periods of time. Always operate the device in accordance with the water rating listed in the device specifications (*Garmin PowerSwitch Specifications, page 14*). Submerging the device in water for prolonged periods of time may cause corrosion on the electrical contacts.

Device Information

Garmin PowerSwitch Specifications

Dimensions (D x W x H)	75 x 125 x 32 mm (2.95 x 4.92 x 1.26 in.)
Operating temperature range	From -25° to 85°C (from -13° to 185°F)
Wireless frequency	2.4 GHz @ 10 dBm
Power input	From 12 to 16 V using the included vehicle power cable.
Maximum accessory output	30 A
Maximum system output	100 A
Current draw with all outputs off	3 mA
Water rating	IEC 60529 IPX7 ¹

¹ The device withstands incidental exposure to water of up to 1 m for up to 30 min. For more information, go to www.garmin.com/waterrating.

Index

A

app overview 9

C

cleaning the device 12

control input 10

current limits 6

D

device, cleaning 13

F

fuse, changing 13

M

mounting the device 3–7, 14

P

pairing 8

 phone 8

phone, pairing 8

power cables

 changing the fuse 13

 vehicle 5–7

power switch 9

 customizing 10–12

R

resetting the device 13

S

smartphone features, connecting 8

software, updating 13

specifications 14

T

troubleshooting 13, 14

V

vehicle power cable 7

